



MARVINACUSTICA

Less noise, **better life.**

Sound Absorbing Panels



Intro	4
<i>Company</i>	
Suonosoft	14
<i>Products Index</i>	
Color & Textiles	54
<i>Only for Suonosoft</i>	
Other Solutions	60
<i>Products Index</i>	
Color & Textiles	74
<i>Only for Comfort</i>	
Fixing Systems	80
<i>Only for Suonosoft & Comfort</i>	

MARVINACUSTICA

Enhancing Comfort

4

Da oltre quarant'anni ci occupiamo di acustica

Marvinacustica è specializzata in soluzioni acustiche di ambienti interni ed esterni con prodotti di design ad elevate prestazioni fonoassorbenti. Da sempre la customizzazione è nel DNA di Marvinacustica, ci proponiamo infatti come partner ideale quando i progetti richiedono soluzioni e idee non convenzionali, studiate e sviluppate appositamente per il singolo progetto.

Siamo in grado di offrire una vasta gamma di prodotti fonoassorbenti e sviluppiamo inoltre progetti, idee e richieste su misura.

Offriamo la soluzione più adatta alle esigenze da disturbo di rumore, in conformità alle normative acustiche in ambiente lavorativo interno ed esterno.

For over forty years we have been dealing with acoustics

Marvinacustica specialises in indoor and outdoor acoustic solutions with design products with high sound absorbing performance. Customisation has always been in Marvinacustica's DNA, and we act as an ideal partner when projects require unconventional solutions and ideas, designed and developed specifically for the individual project.

We offer a wide range of sound absorbing products and also develop customised designs, ideas and requests.

We offer the most suitable solution for noise disturbance needs, in compliance with acoustic regulations in indoor and outdoor work environments.

5

Esperienza e Obiettivi

Fondata con l'obiettivo di migliorare la qualità dell'acustica negli ambienti, la nostra azienda ha acquisito una grande esperienza nel settore grazie alla passione e alla professionalità del nostro team. In Marvinacustica la funzionalità e l'estetica si incontrano per offrire prodotti unici, capaci di migliorare la qualità del suono e allo stesso tempo di arricchire gli ambienti in cui vengono installati. Grazie all'esperienza acquisita negli anni e alle tecnologie avanzate, siamo in grado di realizzare prodotti che si adattano a qualsiasi tipo di ambiente, dallo stile classico al moderno, così da garantire sempre una perfetta armonia con gli spazi circostanti. Marvinacustica rappresenta la scelta ideale per chi cerca prodotti di alta qualità e design.

Experience and Goals

Founded with the aim of improving the quality of room acoustics, our company has acquired a great deal of experience in the industry thanks to the passion and professionalism of our team. At Marvinacustica, functionality and aesthetics meet to offer unique products that improve sound quality and at the same time enrich the environments in which they are installed. Thanks to the experience we have gained over the years and advanced technology, we are able to manufacture products that adapt to any type of environment, from classic to modern style, so that they always ensure perfect harmony with the surrounding spaces. Marvinacustica is the ideal choice for those looking for high quality and design products.

Design Italiano

La collaborazione con designer italiani è un elemento fondamentale per la creazione di prodotti di design di alta qualità e dallo stile unico. Grazie alla loro creatività e alla loro passione per l'eccellenza, i nostri designer italiani sono in grado di interpretare le esigenze del mercato e di trasformarle in prodotti innovativi e di grande impatto estetico. Lavorare a stretto contatto con questi professionisti del design ci consente di combinare la loro visione artistica con la nostra esperienza e conoscenza del prodotto, per dare vita a elementi che rappresentano l'eccellenza del made in Italy.

Italian design

Collaboration with Italian designers is a key element in the creation of high-quality, uniquely styled design products. Thanks to their creativity and passion for excellence, our Italian designers are able to portray the needs of the market and transform them into innovative and aesthetically appealing products. Working closely with these design professionals allow us to combine their artistic vision with our experience and product knowledge to create elements that represent the excellence of Made in Italy.



6



7

Dove e come

I pannelli fonoassorbenti sono il prodotto ideale per correggere il riverbero all'interno di locali dalle diverse destinazioni d'uso: ristoranti, pizzerie, bar, uffici, sale riunioni, hall, reception, stanze per l'ascolto della musica, studi professionali, sale d'attesa, reparti produzione, ecc. Tutti i nostri prodotti vengono prima testati all'interno del nostro laboratorio e su richiesta possiamo fornire le schede dei test acustici. Siamo in grado di fornire un servizio completo composto dalle seguenti fasi:

- ✓ **Rilevazione acustica con strumentazione fonometrica certificata;**
- ✓ **Studio della soluzione;**
- ✓ **Progettazione tecnica;**
- ✓ **Realizzazione di sistemi integrati per l'isolamento acustico;**
- ✓ **Installazione**

Offriamo un servizio di progettazione personalizzato, con l'obiettivo di aiutare i nostri clienti a trovare la soluzione ideale per le loro esigenze. Il nostro servizio di progettazione è caratterizzato dalla massima attenzione ai dettagli e dalla cura per ogni aspetto del progetto, dalla scelta dei materiali alla disposizione dei pannelli fonoassorbenti, per garantire un risultato finale di qualità superiore e soddisfacente per il cliente. Siamo orgogliosi di offrire un servizio di progettazione su misura, che rappresenta il valore aggiunto della nostra azienda.

Where and how

Sound-absorbing panels are the ideal product for correcting reverberation inside rooms with different uses: restaurants, pizzerias, bars, offices, meeting rooms, halls, receptions, music listening rooms, professional studios, waiting rooms, production departments, etc. All our products are first tested in our workshop, and we can provide acoustic test sheets on request. We are able to provide a comprehensive service consisting of the following steps:

- ✓ **Acoustic survey with certified phonometric instrumentation;**
- ✓ **Solution study;**
- ✓ **Technical design;**
- ✓ **Implementation of integrated sound insulation systems.**
- ✓ **Installation**

We offer a customised design service, with the aim of helping our customers find the ideal solution for their needs. Our design service is characterised by the utmost attention to detail and care for every aspect of the project, from the choice of materials to the layout of the acoustic panels, to ensure a superior and satisfying end result for the customer. We are proud to offer a bespoke design service, which represents the added value of our company.

Servizi, prodotti e soluzioni firmati Marvinacustica

Siamo orgogliosi di poter dire che ogni nostro prodotto è cucito a mano con la massima cura e attenzione ai dettagli. La cucitura a mano garantisce precisione poiché permette di controllare ogni singolo punto di cucitura. Inoltre, il fatto che i nostri pannelli fonoassorbenti vengano cuciti a mano significa che ogni prodotto è unico e ha il suo carattere distintivo.

I nostri pannelli fonoassorbenti sono progettati per garantire la massima qualità del rivestimento, grazie all'utilizzo di materiali di prima scelta e all'attenzione per i dettagli nella fase di produzione. I nostri pannelli sono disponibili in una vasta gamma di colori e texture, che si integrano perfettamente in ogni contesto architettonico e decorativo.

Services, products and solutions by Marvinacustica

We are proud to say that each of our products is hand-sewn with the utmost care and attention to detail. Hand stitching guarantees precision as it allows each individual stitch to be controlled. Furthermore, the fact that our acoustic panels are hand-sewn means that each product is unique and has its own distinctive character.

Our sound-absorbing panels are designed to guarantee the highest quality of cladding, thanks to the use of premium materials and attention to detail in the production phase. Our panels are available in a wide range of colours and textures, blending perfectly into any architectural and decorative context.



10



11

Qualità & Sostenibilità

Siamo consapevoli che la scelta dei materiali influisce non solo sulla funzionalità dei nostri prodotti, ma anche sull'estetica e sulla durabilità. Per questo motivo, selezioniamo con cura i materiali migliori sul mercato, con una particolare attenzione alla sostenibilità ambientale. Utilizziamo materiali di alta qualità e siamo alla continua ricerca di nuove tecnologie e soluzioni innovative per migliorare i nostri prodotti e soddisfare le esigenze dei clienti.

La sostenibilità rappresenta per noi un impegno costante. Siamo consapevoli dell'importanza di ridurre l'impatto ambientale della nostra produzione, ed è per questo che adottiamo le migliori pratiche in termini di sostenibilità e di rispetto per l'ambiente. La sostenibilità è per noi un impegno costante e una priorità in ogni fase del nostro processo produttivo, dalla progettazione alla realizzazione dei nostri prodotti, per offrire soluzioni di alta qualità in linea con le esigenze del nostro pianeta.

Quality & Sustainability

We are aware that the choice of materials affects not only the functionality of our products, but also aesthetics and durability. For this reason, we carefully select the best materials on the market, with a focus on environmental sustainability. We use high quality materials and are constantly looking for new technologies and innovative solutions to improve our products and meet our customers needs.

Sustainability is an ongoing commitment for us. We are aware of the importance of reducing the environmental impact of our production, which is why we adopt best practices in terms of sustainability and respect for the environment. Sustainability is an ongoing commitment for us and a priority at every stage of our production process, from design to manufacture.



Slice	16	Esagono	36
Morning	18	Biscotto	38
Angle	20	Foglio	40
Petalo	22	Smart W	42
Mimetico	24	Plettro T	44
Sky	26	Forest	46
Scudo	28	Wave	48
Plettro	30	Turtle T	50
Circle	32	WallT	52
Grappolo	34		

SUONOSOFT *Silence by Design*

SLICE

/slais/

Design by
Luigi Siard



Slice 60°
L 53 cm
H 52 cm
T 3-5 cm
A 0,32 m²



Slice 90°
L 76 cm
H 55 cm
T 3-5 cm
A 0,5 m²



Slice 120°
L 94 cm
H 56 cm
T 3-5 cm
A 0,7 m²



Slice 180°
L 130 cm
H 57 cm
T 3-5 cm
A 1,0 m²

16



17



18

MORNING

/mAWnIng/

Design by
Matteo Leorato



Morning
L 75 cm
H 32 cm
T 3-5 cm
A 0,34 m²

19

ANGLE

/'æŋ.gəl/

Design by
Matteo Leorato



Angle maxi
L 60 cm
H 60 cm
T 3-5 cm
A 0,54 m²



Angle mini
L 46 cm
H 46 cm
T 3-5 cm
A 0,32 m²

20



21



PETALO

/'petalo/

Design by
Matteo Leorato



Petalo 100
L 100 cm
H 100 cm
T 3-5 cm
A 0,85 m²



Petalo 50
L 50 cm
H 50 cm
T 3-5 cm
A 0,21 m²

MIMETICO

/mi'mε.ti.ko/

Design by
Luigi Siard



Mimetico 4
L 40 cm
H 46 cm
T 3-5 cm
A 0,14 m²



Mimetico 3
L 57 cm
H 76 cm
T 3-5 cm
A 0,28 m²



Mimetico 2
L. 70 cm
H. 89 cm
T 3-5 cm
A. 0,38 m²



Mimetico 1
L. 80 cm
H. 117 cm
T 3-5 cm
A. 0,57 m²

24



25



SKY

/skIE/

Design by
Luigi Siard



Sky 1

L 136 cm
H 97 cm
T 3-5 cm
A 0,84 m²



Sky 2

L 105 cm
H 67 cm
T 3-5 cm
A 0,46 m²



Sky 3

L 114 cm
H 88 cm
T 3-5 cm
A 0,65 m²



Sky 4

L 119 cm
H 73 cm
T 3-5 cm
A 0,54 m²



Sky 5

L 90 cm
H 70 cm
T 3-5 cm
A 0,40 m²



Sky 6

L 95 cm
H 57 cm
T 3-5 cm
A 0,35 m²



Sky 7

L 73 cm
H 47 cm
T 3-5 cm
A 0,22 m²



Sky 8

L 60 cm
H 38 cm
T 3-5 cm
A 0,16 m²

SCUDO

/'skudo/

Design by
Luigi Siard



Scudo 100
L. 100 cm
H. 100 cm
T. 3-5 cm
A. 0,85 m²



Scudo 50
L. 50 cm
H. 50 cm
T. 3-5 cm
A. 0,21 m²

28



29



PLETTRO

/pl'ɛt:ro/

Design by
Luigi Siard



Plettro
L 69 cm
H 63 cm
T 3-5 cm
A 0,30 m²

30

31

CIRCLE

/s'ɜ:kəl/

Design by
Marvinacustica



Circle 100
L 100 cm
H 100 cm
T 3-5 cm
A 0,77 m²



Circle 70
L 70 cm
H 70 cm
T 3-5 cm
A 0,38 m²



Circle 50
L 50 cm
H 50 cm
T 3-5 cm
A 0,19 m²

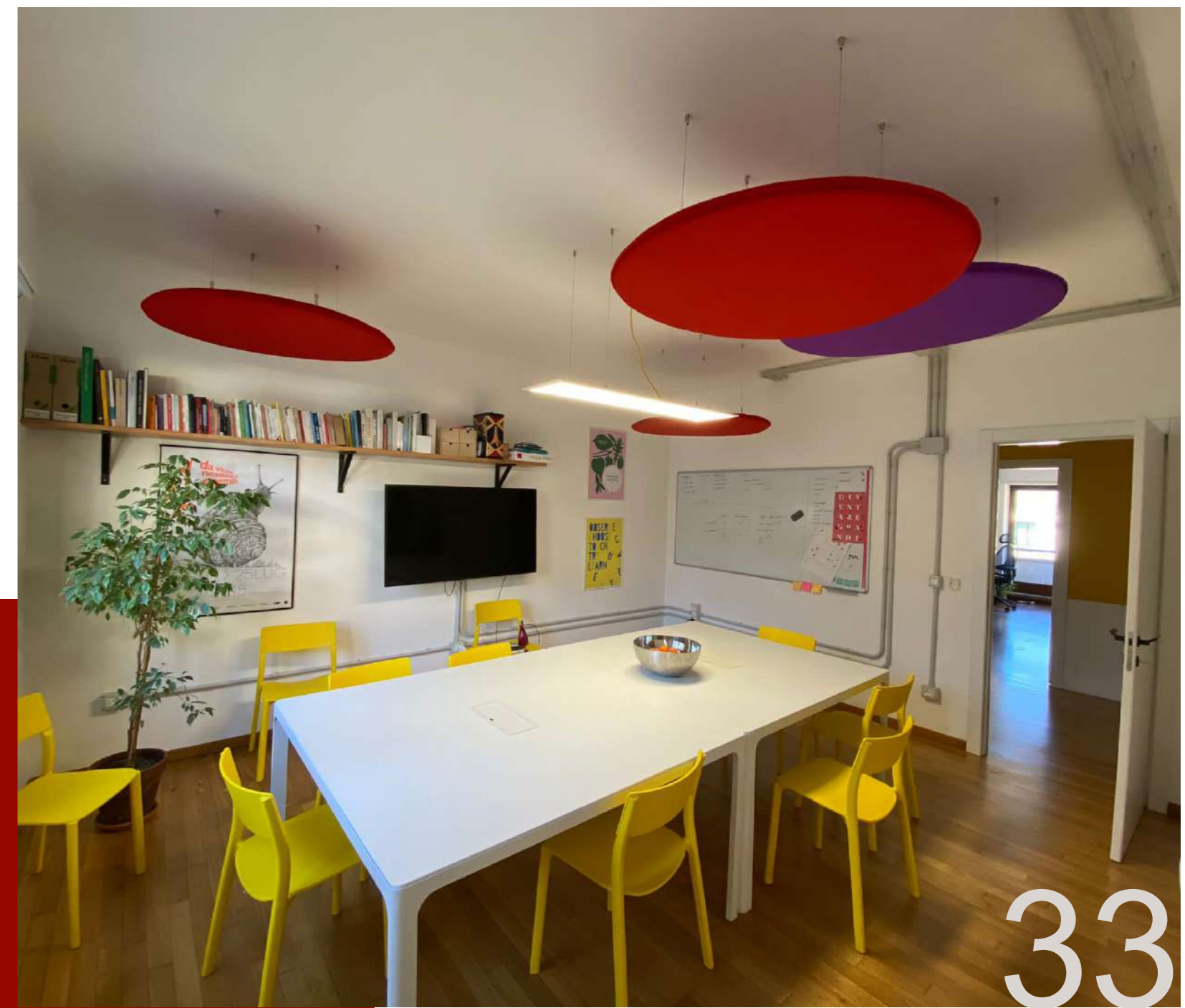



GRAPPOLO

/gr'ap:olo/

Design by
Marvinacustica



Grappolo
L. 100 cm
H. 140 cm
T. 3-5 cm
A. 3,2 m²

ESAGONONO

/ez'agono/

Design by
Marvinacustica



Esagono 100
L. 100 cm
H. 90 cm
T. 3-5 cm
A. 0,67 m²



Esagono 75
L. 75 cm
H. 67 cm
T. 3-5 cm
A. 0,38 m²



Esagono 55
L. 50 cm
H. 57 cm
T. 3-5 cm
A. 0,21 m²

36



37



38

BISCOTTO

/bisk'ɔt:o/

Design by
Marvinacustica



Biscotto 150
L 50 cm
H 150 cm
T 3-5 cm
A 0,70 m²



Biscotto 100
L 50 cm
H 100 cm
T 3-5 cm
A 0,45 m²



Biscotto 95
L 25 cm
H 95 cm
T 3-5 cm
A 0,24 m²



Biscotto 50
L 25 cm
H 50 cm
T 3-5 cm
A 0,11 m²

39

FOGLIO

/f'ɔʎo/

Design by
Marvinacustica



Foglio 80
L 80 cm
H 50 cm
T 5 cm
A 0,40 m²



Foglio 100
L 100 cm
H 50 cm
T 5 cm
A 0,50 m²



Foglio 150
L 150 cm
H 50 cm
T 5 cm
A 0,75 m²

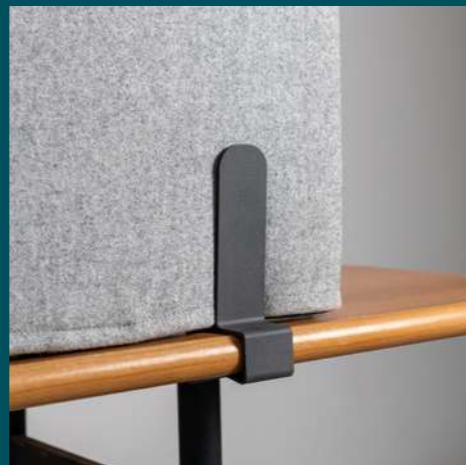

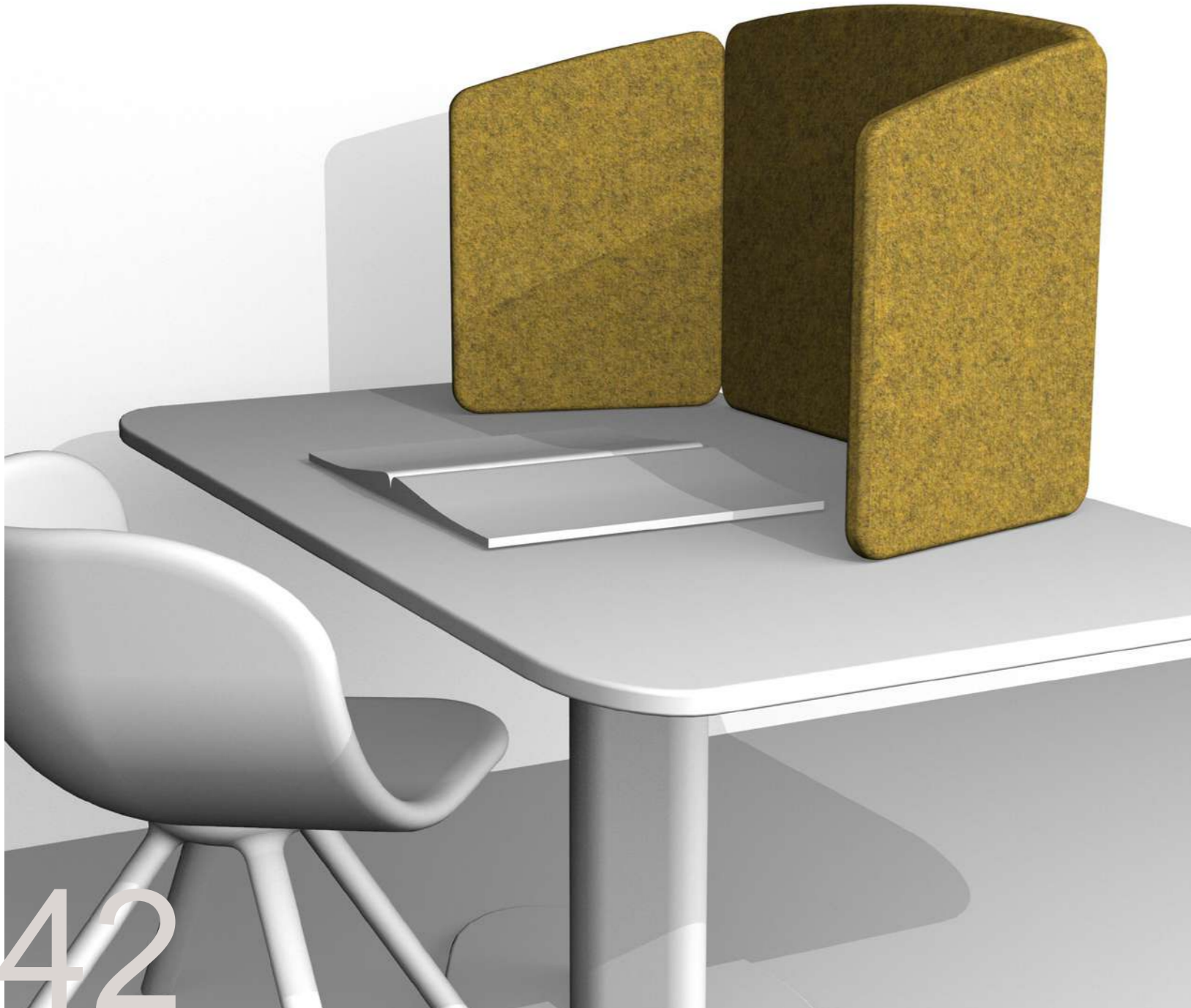

SMART W

/sm'a:ɹt d'ʌbəlʝ, u: /

Design by
Marvinacustica



Smart W
L. 106 cm
H. 60 cm
T. 5 cm
A. 1,77 m²

PLETTRO T

/pl'ɛt:ro t'i/

Design by
Luigi Siard



Plettro 130T
L 90 cm
H 130 cm
T 5 cm
A 1,64 m²



Plettro 150T
L 100 cm
H 150 cm
T 5 cm
A 2,20 m²

44



45



46

FOREST

/f'ɔ:ɹɪst/

Design by
Luigi Siard



Forest
L 97 cm
H 136 cm
T 5 cm
A 1,68 m²

47

WAVE

/w'eiv/

Design by
Marvinacustica



Wave 140
L 80 cm
H 140 cm
T 5 cm
A 1,66 m²



Wave 160
L 100 cm
H 160 cm
T 5 cm
A 2,30m²





TURTLET

/t'ɜ:rəl t'i:/

Design by
Luigi Siard



Turtle T
L. 100 cm
H. 150 cm
T. 5 cm
A. 2,30 m²

50

51

WALL T

/w'ɔ:l t'i:/

Design by
Marvinacustica

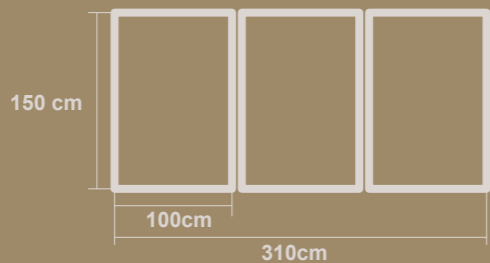

52





YOUR CHOICE

Colors & Textiles

for Suonosoft

Colors 56

Materials 58

COLORS

Wool 100%

56

only for Suonosoft

MELANGE

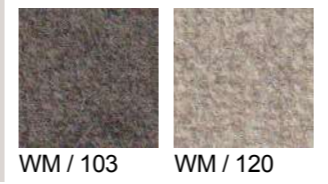
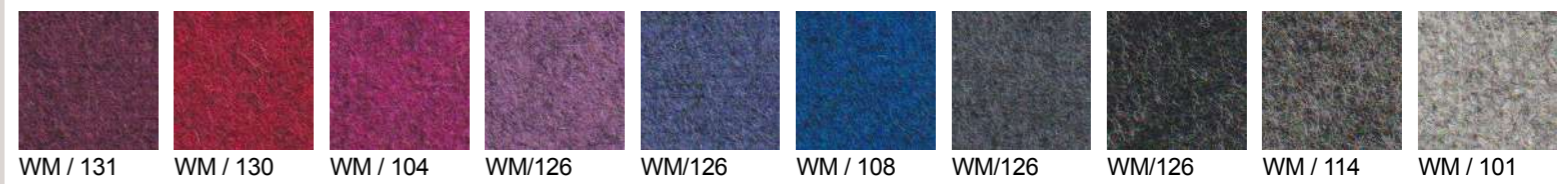
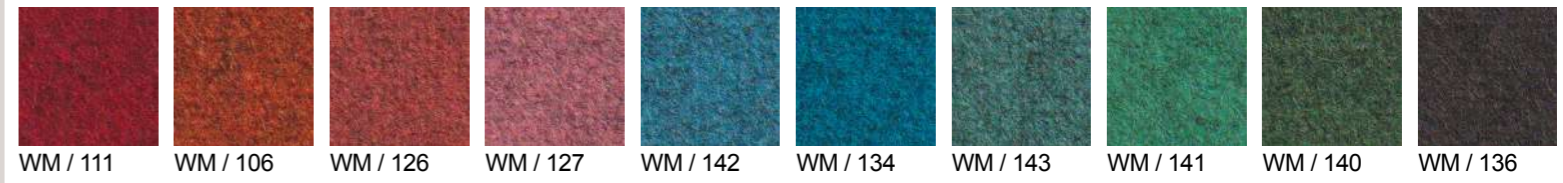
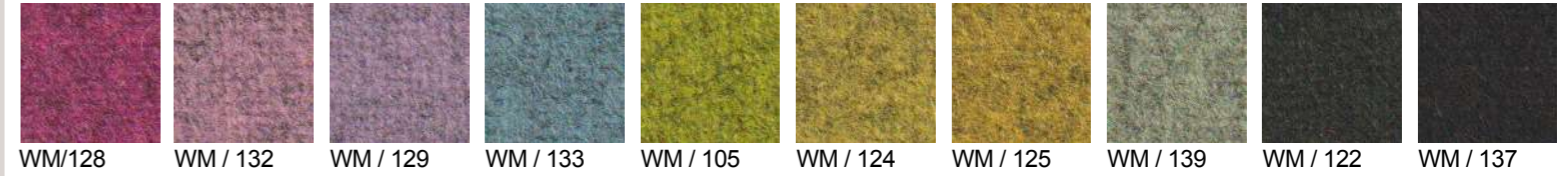

PLAIN COLOR

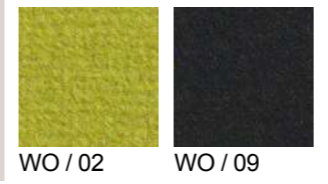
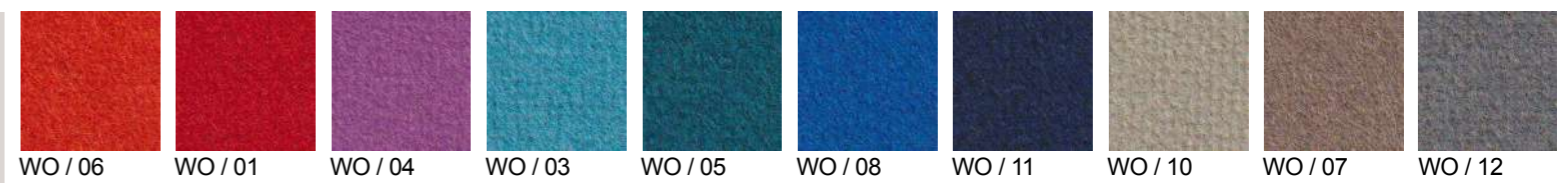

57

MATERIALS

*High quality,
better results*

58

only for Suonosoft



Lanee Melange

Tessuto ignifugo tipo panno composto 100% pura lana vergine.

Resistenze:

- abrasione: 50000 cicli Martindale
- luce (EN ISO 105-B02): 5
- sfregamento (EN ISO 105-X12) umido 4/5, secco 5
- UNI EN ISO 354:2003
- Misura dell'assorbimento acustico in camera riverberante

Lanee Melange

Fire retardant cloth-type fabric made of 100% pure virgin wool.

Resistances:

- abrasion: 50000 Martindale cycles
- light (EN ISO 105-B02): 5
- chafing (EN ISO 105-X12) wet 4/5, dry 5
- UNI EN ISO 354:2003
- Sound absorption measurement in reverberation chamber



59

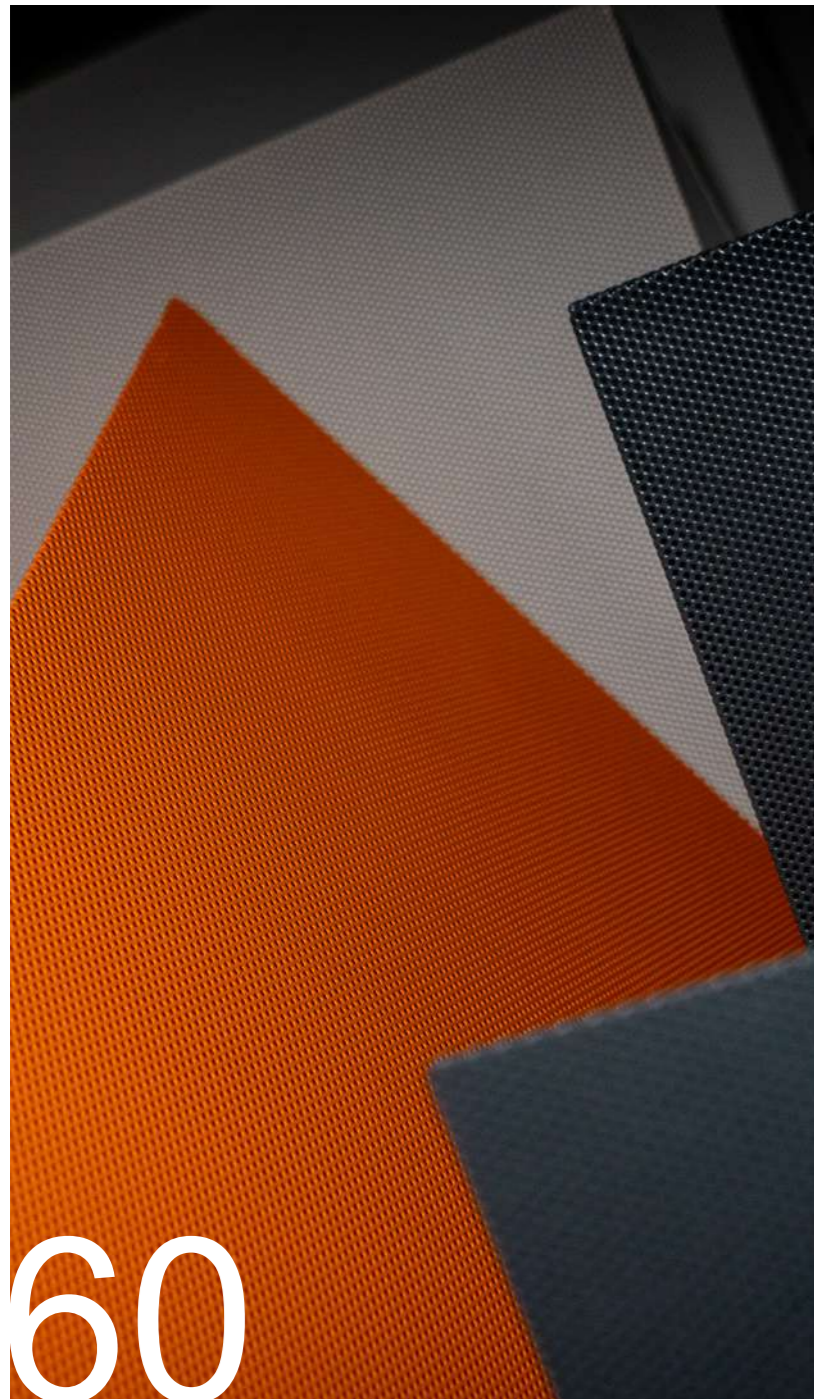

Prima	62
Tacos	64
Comfort	66
View	68
Dot	70
White	72

OTHER SOLUTIONS

As you desires

PRIMA

/pr'ima/

PRIMA è una Phone Booth progettata per chi ha bisogno di spazi privati e privi di rumore all'interno del proprio ambiente lavorativo. Che si tratti di un piccolo o di un grande ufficio, PRIMA è perfetta per garantire funzionalità e gestione degli spazi. È dotata di 3 zone vetrate, in grado di donare spazio e luminosità all'ambiente

PRIMA is a Phone Booth designed for those who need private, noise-free space within their working environment. Whether in a small or large office, PRIMA is perfect for ensuring functionality and space management. It is equipped with 3 glazed areas, giving space and brightness to the environment.

Prima
L 1000 mm
P 1040 mm
H 2250 mm

62



63



64

TACOS

/t'akos/

Tacos è un angolo di quiete versatile e regolabile, adatto a spazi comuni e pensato per migliorare il proprio comfort acustico e luminoso. Nella versione con piede le posizioni sono determinate al momento dell'installazione, esiste anche una versione dal moto delicatamente instabile.

Tacos is a versatile and adjustable quiet corner, suitable for communal spaces and designed to improve acoustic and lighting comfort. In the foot version the positions are determined at the time of installation, there is also a version with a gently unstable motion.

Design by
Luigi Siard



Tacos Stop
L 110 cm
H 146 cm
T da 2 cm
A 5,2 m²

Tacos Move
L 110 cm
H 142 cm
T da 2 cm
A 5,4 m²

65

COMFORT

/k'ʌmfət/

La linea di pannelli fonoassorbenti COMFORT è realizzata con un bordo rigido e con rivestimento in tessuto in colore a scelta. COMFORT offre la possibilità di rivestire intere superfici.

The COMFORT line of sound-absorbing panels is made with a rigid border and covered in fabric in a colour of your choice. COMFORT offers the possibility of covering entire surfaces.

Dimensione massima:
1200 x 3000 mm
Spessore: 25 o 40 mm

Dimensioni personalizzabili su richiesta

Maximum size:
1200 x 3000 mm
Thickness: 25 or 40 mm

Dimensions customisable on request.

66



67



VIEW

/vj'u:/

La linea di pannelli fonoassorbenti VIEW ti permette di stampare in alta definizione, su tutte le superfici a vista del pannello, un'immagine a scelta su un tessuto microforato in PVC.

The VIEW line of acoustic panels allows you to print in high definition, on all visible surfaces of the panel, an image of your choice on a micro-perforated PVC fabric.

View Mini

L 80 cm
H 80 cm
T 5 cm
A 0,54 m²

View Medium

L 80 cm
H 120 cm
T 5 cm
A 0,54 m²

View Maxi

L 100 cm
H 160 cm
T 5 cm
A 0,54 m²

Dimensioni personalizzabili
su richiesta

*Dimensions customisable on
request*

DOT

/d'ɑ:t/

La linea di pannelli fonoassorbenti DOT è creata da una struttura esterna molto leggera in lamiera microforata di alluminio. Il materiale fonoassorbente interno è costituito da fibra di poliestere in Classe 1 di reazione al fuoco.

The DOT line of sound-absorbing panels is created by a very light external structure of micro-perforated aluminium sheet metal. The internal sound-absorbing material is made of Class 1 fire-resistant polyester fibre.

DOT-A	DOT-B	DOT-C	DOT-D
L 47,5 cm	L 47,5 cm	L 47,5 cm	L 110 cm
H 47,5 cm	H 110 cm	H 235 cm	H 235 cm
T 3-5 cm	T 3-5 cm	T 3-5 cm	T 3-5 cm
A 0,54 m ²	A 0,54 m ²	A 0,54 m ²	A 0,54 m ²

Dimensioni, forme e colore personalizzabili su richiesta

Dimensions customisable on request.

70

71

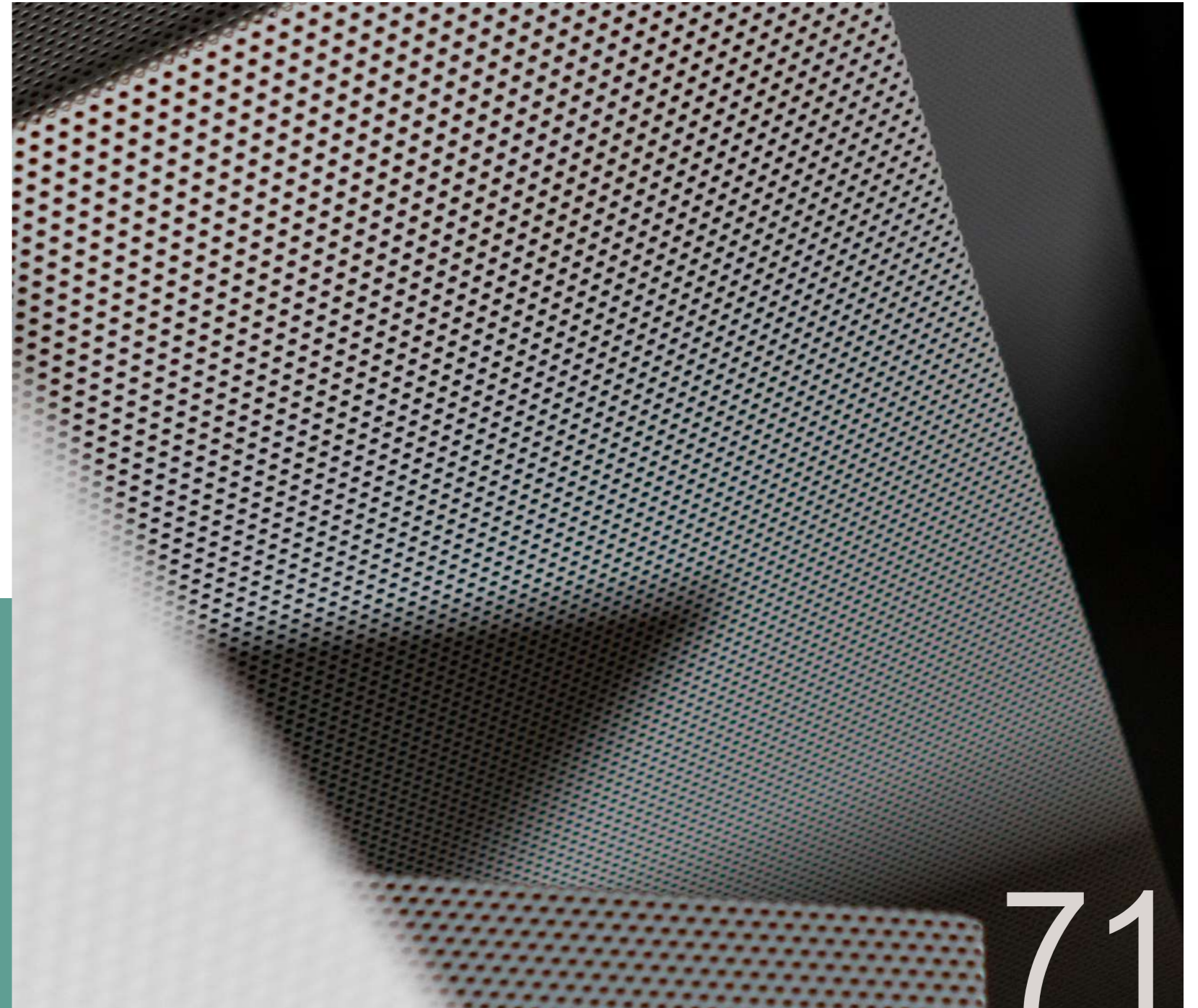



WHITE

/w'ait/

La linea di pannelli fonoassorbenti WHITE STAR è rivestita in pittura bianca su un solo lato (bordi compresi). La linea di pannelli fonoassorbenti WHITE BR-BS è rivestita in pittura bianca su entrambi i lati (bordi compresi), per essere utilizzati anche a baffle.

The WHITE STAR sound absorber line is coated in white paint on one side only (including edges). The WHITE BR-BS line of sound-absorbing panels is coated in white paint on both sides (including edges), so they can also be used in baffles.

Star

L 60 cm
H 120 cm
T 3 cm

BR1

L 120 cm
H 180 cm
T 4 cm

BR2

L 120 cm
H 240 cm
T 4 cm

BS

L 120 cm
H 120 cm
T 4 cm



74

YOUR CHOICE

Colors & Textiles for Comfort

Colors

76

75

COLORS

Your Style

76

only for Comfort

ERA

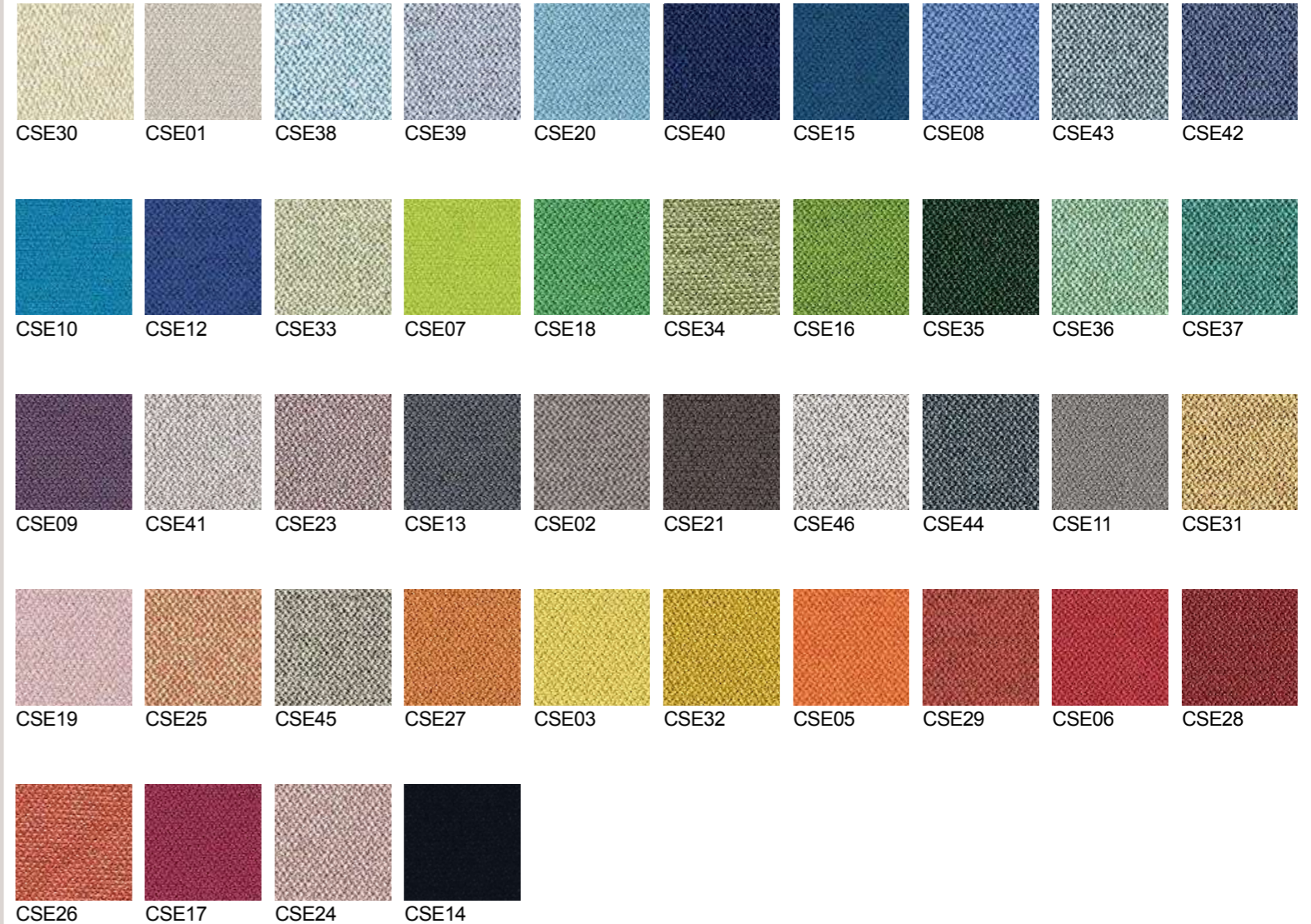

77

CARA

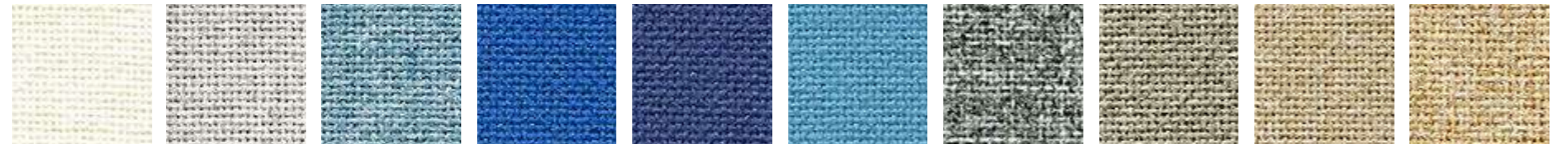

EJ184 EJ004 EJ105 EJ125 EJ154 EJ175 EJ104 EJ033 EJ192 EJ173

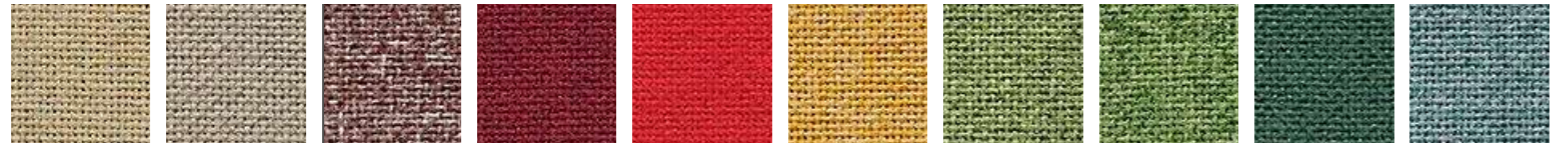

EJ193 EJ191 EJ197 EJ038 EJ076 EJ195 EJ186 EJ185 EJ187 EJ189

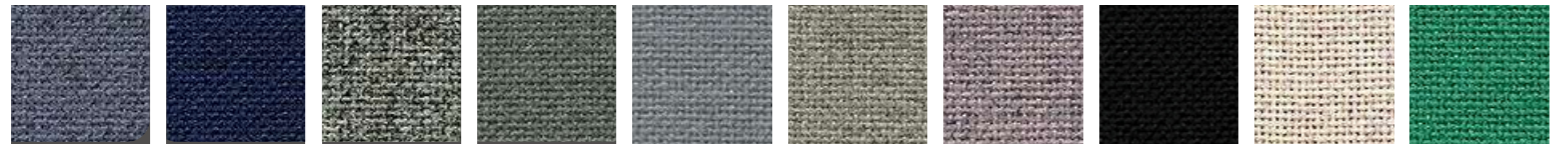

EJ188 EJ011 EJ016 EJ048 EJ172 EJ190 EJ196 EJ138 EJ169 EJ015

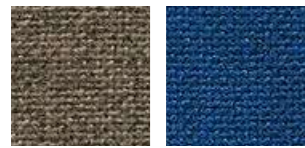

EJ194 EJ180

LUCIA

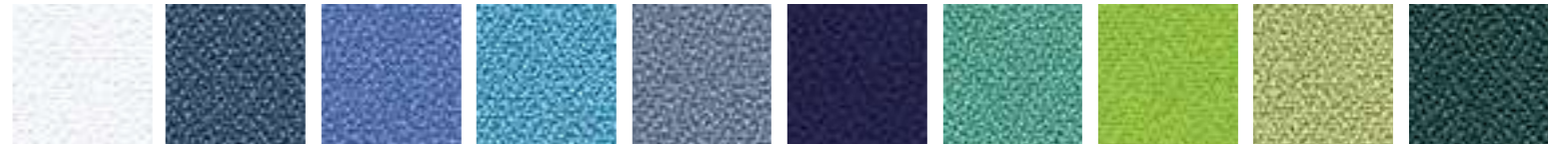

YB165 YB004 YB097 YB157 YB095 YB100 YB301 YB156 YB096 YB047

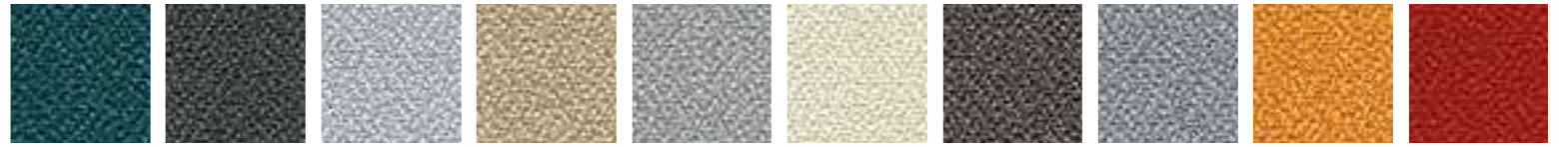

YB011 YB019 YB086 YB093 YB094 YB107 YB108 YB170 YB088 YB106

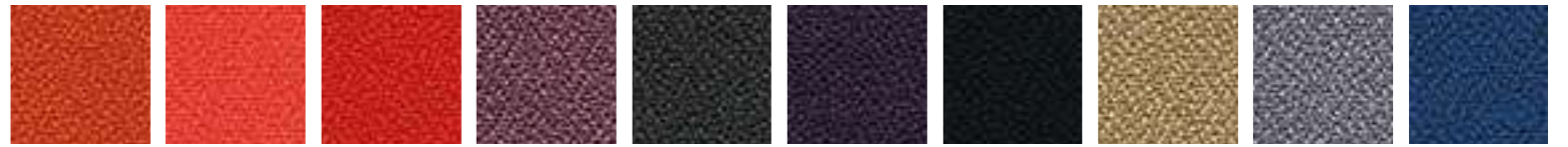

YB087 YB168 YB105 YB102 YB046 YB090 YB009 YB302 YB038 YB089



YB026

SONUS

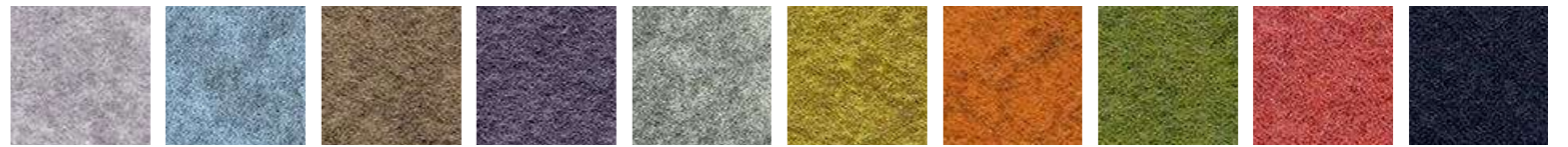

FHR02 FHR06 FHR07 FHR13 FHR03 FHR01 FHR09 FHR12 FHR17 FHR16



FHR05 FHU04 FHU08 FHU10 FHU11 FHU14 FHU15



FIXING SYSTEMS

Where you need

80

81

FIXING SYSTEMS

From walls to ceilings

82

only for Suonosoft / Comfort

Fissaggio meccanico removibile

Mechanic fixing

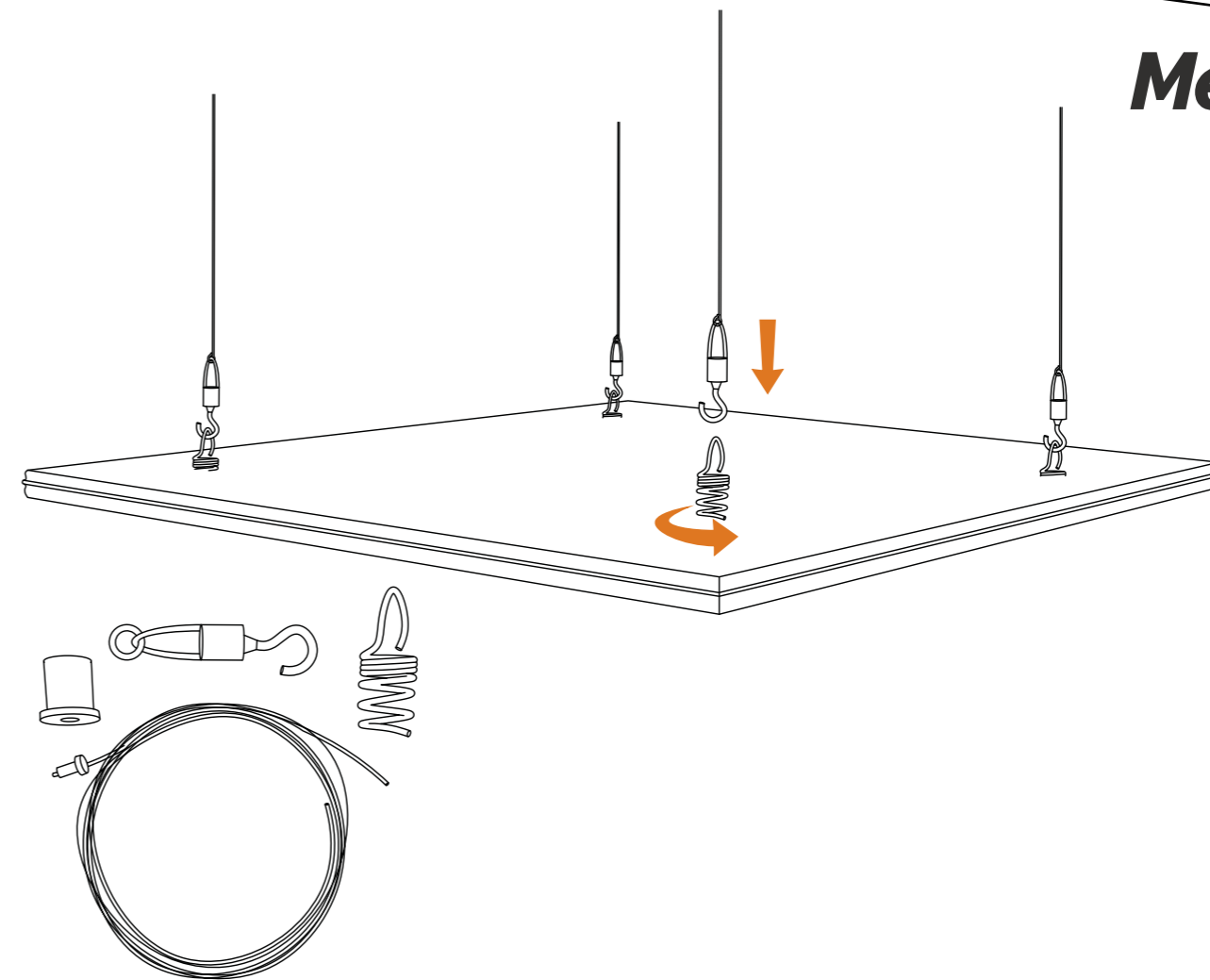

83

Fissaggio meccanico removibile

Mechanic fixing

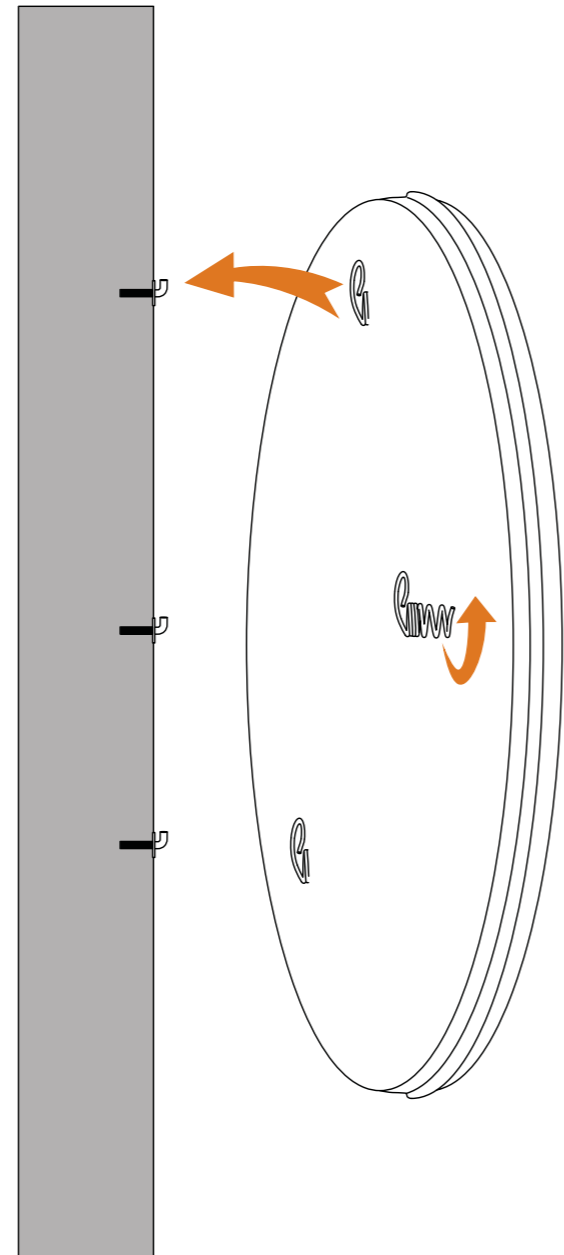

84

Fissaggio magnetico removibile

Magnetic fixing

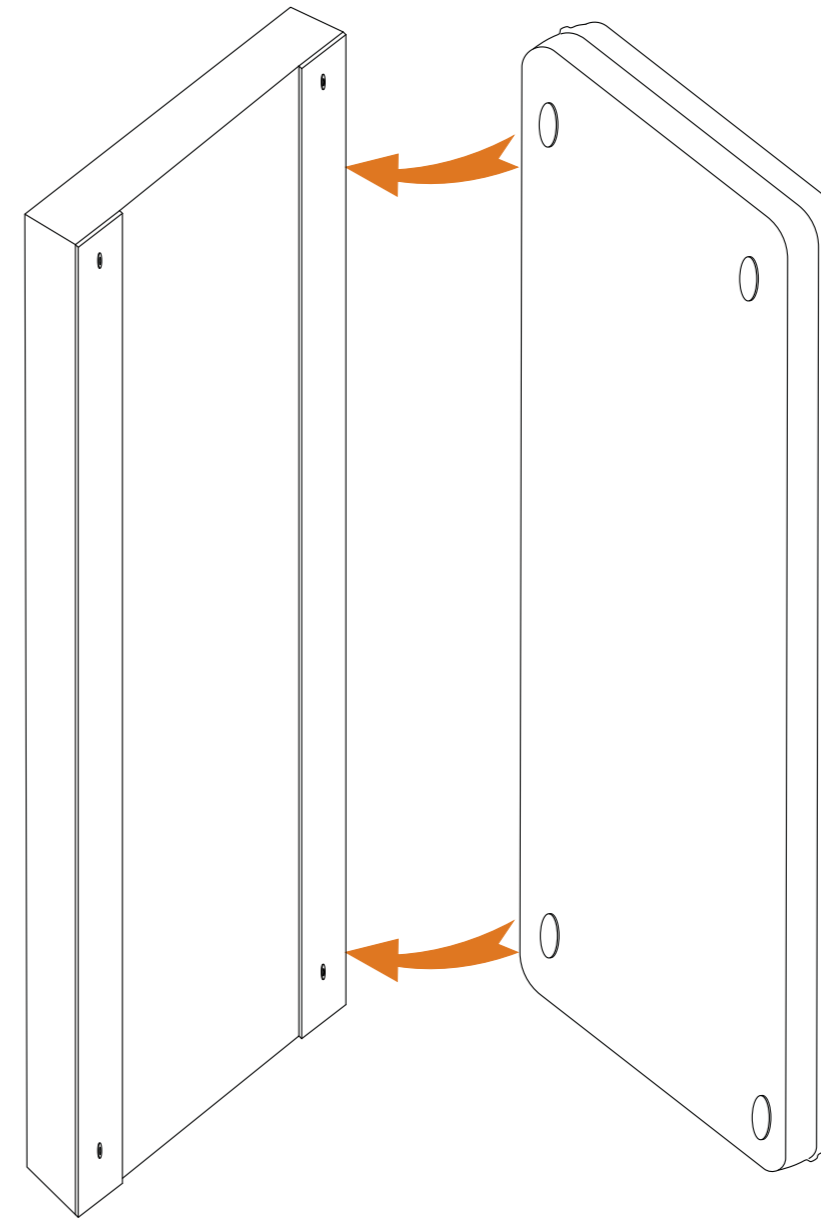

85



MARVINACUSTICA
Less noise, **better life.**

MARVINACUSTICA S.r.l.
Via Lago di Tovel, 10
36015 Schio (VI) Italy
T +39 0445 575669
info@marvinacustica.it

www.marvinacustica.it



MARVINACUSTICA

Less noise, **better life.**

www.marvinacustica.it